

TOYOTA **LET'S
GO
BEYOND**

ALL NEW **HILUX** **RANGGA**

TERUS MAJU USAHA MELAJU



Standard Type
Dilengkapi dengan TCO Parts

<p>149 PS* MESIN MANTAP AKSELERASI CEPAT <small>*DSL Type</small></p> 	<p>RADIUS PUTAR 4,9m* LINCAH & GESIT <small>*STD Grade</small></p> 	<p>BUKAAN 1 DAN 3 ARAH</p> 	<p>AMAN DENGAN KAP MESIN</p> 	<p>KABIN NYAMAN</p> 	<p>JARINGAN SERVIS LUAS</p> 
--	---	--	---	--	--



TERUS MELAJU SIGAP MENGANTAR

Standard Type
Dilengkapi dengan TCO Parts

1 3 PIECES OF
FRONT BUMPER
(All Type)

2 HALOGEN
HEADLAMP
(All Standard &
High M/T Type)

BAK LUAS KAPASITAS BESAR

All New Hilux Rangga menyediakan kapasitas bak yang luas. Mendukung usaha Anda untuk terus siap mengantar beragam muatan.



Mampu membawa 56 galon air.

JUANG MATERIAL



Standard Type
Dilengkapi dengan TCO Parts



**TERUS MAJU
DI SEGALA MEDAN**

BUKAAN 3 ARAH
(All Standard Type)

EURO-4

All New Hilux Rangga tersedia dua pilihan bahan bakar: **Diesel** dan **Bensin**.



DIESEL TYPE

**149 PS
343 Nm**



GASOLINE TYPE

**139 PS
183 Nm**



**RADIUS PUTAR
4,9 meter***

*Standard Type (High Type: 5,3m)

TERUS MAJU LANJUT MENGANTAR



1
AIR BLOWER
(Diesel Standard Type)

2
**PRACTICAL STORAGE
DASHBOARD**
(All Type)

3
**1DIN AUDIO WITH
BLUETOOTH & COIN BOX**
(All Standard & High M/T Type)

4
**COMFORTABLE STEERING
WITH TILT ADJUSTMENT**
(All Type)

Standard Type
Dilengkapi dengan TCO Parts



POSISI DUDUK NYAMAN & ERGONOMIS

Dilengkapi dengan **Reclining Seat** untuk pengemudi (All Type) & penumpang (High A/T Type).

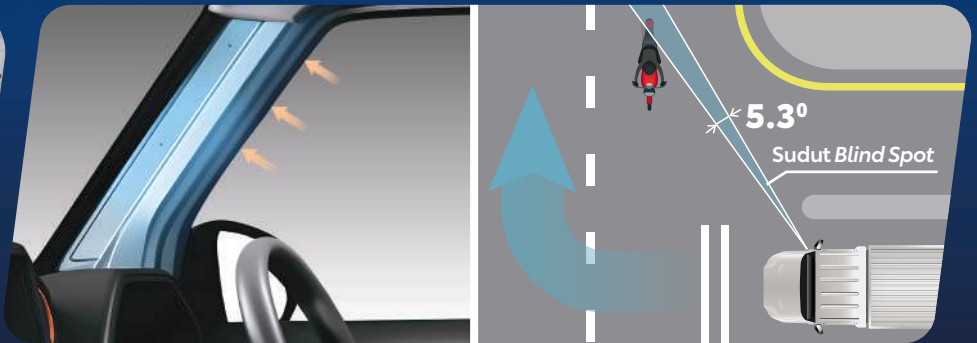
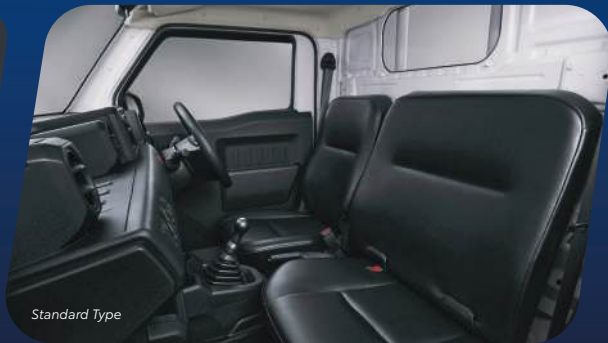

DESAIN DENGAN VISIBILITAS BAIK

All New Hilux Rangga memiliki desain kabin dengan kaca depan yang luas dan kaca spion yang lebih besar untuk memberikan visibilitas yang lebih baik bagi pengendara. (All Type)



Diesel High A/T Type

*Gambar hanya ilustrasi.



Diesel High A/T Type
Dilengkapi dengan TCO Parts

TERUS MAJU NYAMAN BERKENDARA

1

SIDE UNDERRUN
(All Deck Type)

2

OUTER MIRROR WITH ELECTRIC ADJUSTMENT
(Diesel High A/T Type)

3

LED PROJECTOR HEADLAMP WITH DRL
(Diesel High A/T Type)

4

SILVER TOYOTA EMBLEM & GRILL WITH PAINTING
(Diesel High A/T Type)



Diesel High A/T Type

5. 2DIN AUDIO WITH BLUETOOTH
(Diesel High A/T Type)

7. POWER WINDOW
(Diesel High A/T Type)

6. AIR CONDITIONER
(All High & Gasoline Standard Type)

8. ORANGE INTERIOR ACCENT
(Diesel High A/T Type)



Diesel High A/T Type

9. HEADREST
(All High Type)

10. SEPARATE SEAT
(Diesel High A/T Type)



MULTI-INFORMATION DISPLAY
(High Type)

TEMPERATUR TERJAGA DAN LEBIH STABIL



- Pengaturan suhu terletak di kabin.
- Menjaga suhu -25°C sampai dengan 20°C.
- Didukung dengan kapasitas alternator yang besar (80A).



Cool Box Standard Type
Dilengkapi dengan TCO Parts

TERUS MAJU TENANG DI JALAN

JARINGAN SERVICE & SPARE PART TERSEBAR DI MANA-MANA

Didukung oleh berbagai pilihan parts dengan

HARGA BERSAING



Tersebar di seluruh Indonesia*

312

37

> 1000

BENGKEL RESMI

OTOXPRT

PART SHOP PARTNER

*As per July 2024



Bebas Biaya Jasa dan Suku Cadang hingga 6 Bulan/10.000 km



SAFETY & SECURITY

Dry Box Standard Type
Dilengkapi dengan TCO Parts

Dengan ABS
Tanpa ABS

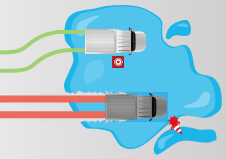

ANTI-LOCK BRAKE SYSTEM
(All High Type)

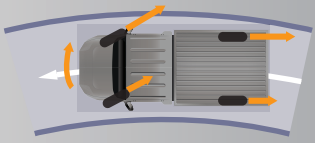

ELECTRONIC BRAKE-FORCE DISTRIBUTION
(All High Type)



IMMOBILIZER
(All High Type)

Perangkat keamanan elektronik yang dipasang pada kendaraan untuk melindungi dari pencurian.



3 POINT RETRACTABLE SEAT BELT
(All Type)
WITH ELR & WARNING (High Type)

Memberikan keamanan optimal dengan seat belt yang dapat menyesuaikan dengan badan pengemudi dan penumpang.



AIRBAG
(All High Type)

Tersedia pada kursi pengemudi dan penumpang untuk melindungi selama perjalanan.

TOYOTA CUSTOMIZATION OPTION

Scan untuk informasi terkait ketersediaan paket TCO:



Ketersediaan TCO mungkin bervariasi serta bergantung pada tipe produk dan area. Silahkan menghubungi Dealer Toyota terdekat untuk informasi lebih lanjut.



IP GARNISH
(All M/T Type)



COVER GLOVE BOX
(All Type)



SPORTY SHIFT KNOB
(Diesel High A/T Type)



OUTER MIRROR COVER
(All Type)



BED LINER
(All Flat Deck)



SIDE VISOR
(All Standard Type)



FRONT CORNER SENSOR
(All Type)



TOYOTA EMBLEM
(All Type)



Solusi integrasi yang dapat diakses melalui aplikasi mTOYOTA untuk berikan kenyamanan, ketenangan, dan menjaga Anda terhubung dengan mobil Anda. (All Type)



FIND MY CAR



GEOFENCING



DRIVING REPORT



GUEST DRIVER ALERT



SPEED & IDLE ALERT



TIME FENCING



G Fleet hadir sebagai solusi konektivitas antara Anda dengan armada Toyota Anda melalui platform web khusus* yang dioptimasi untuk kebutuhan pengawasan armada secara *real-time*.** (All Type)

*Dioptimisasi untuk akses melalui PC/Notebook.

**Tersedia di Dealer Toyota tertentu secara bertahap. Silahkan hubungi Dealer terdekat untuk informasi lebih lanjut.



LOCATION TRACKING
Memonitor lokasi kendaraan secara langsung dan membuat laporan perjalanan untuk menunjang operasional kendaraan.



OVERSPEEDING ALERT
Memberikan notifikasi ketika kendaraan Anda melewati batas kecepatan yang telah ditentukan sebelumnya.



LONG DRIVE
Memberikan notifikasi jika kendaraan Anda bergerak lebih dari 120 menit.



GEOFENCING
Memberikan notifikasi ketika kendaraan Anda keluar/masuk ke wilayah yang telah ditentukan.



UNPLUG DETECTION
Memberikan informasi jika perangkat konektivitas kendaraan dicabut tanpa otorisasi pemilik.



VEHICLE MILEAGE
Memantau jarak tempuh kendaraan secara langsung untuk memberikan keamanan kendaraan Anda.



DRIVER BEHAVIOUR ALERT
Mencatat perilaku pengemudi pada saat berkendara dan memberikan notifikasi secara langsung kepada pemilik kendaraan.



LOW VOLTAGE
Memberikan notifikasi ketika kapasitas aki kendaraan mulai lemah.



REPORT GENERATOR
Mencatat status kendaraan, rangkuman informasi perjalanan, hingga laporan pelanggaran Geofencing yang dapat diunggah secara otomatis.

TERUS MAJU DENGAN KONVERSI BERAGAM INDUSTRI



Jaminan kualitas **TOYOTA CERTIFIED CONVERSION** dengan kemudahan servis di seluruh jaringan bengkel TOYOTA.

CAB & CHASSIS

(All Standard and Diesel A/T Type)



FLAT DECK

(All Type)

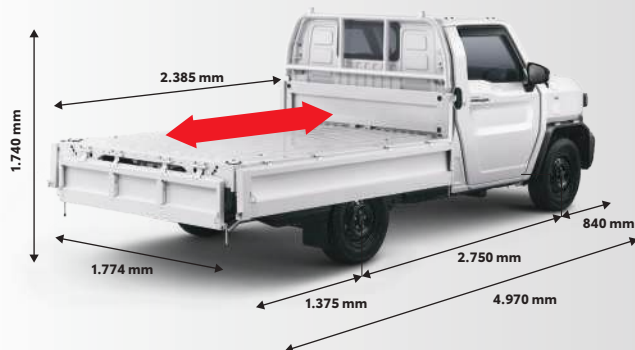

COOL BOX

(All Standard Type)



Material		XPS	
Dimensi Kendaraan (P x L x T)		mm	5.050 x 1.800 x 2.430
Dimensi Kargo	Kargo Bagian Luar (P x L x T)	mm	2.380 x 1.800 x 1.670
	Kargo Bagian Dalam (P x L x T)	mm	2.150 x 1.580 x 1.320
Volume	Kargo Bagian Luar	m ³	7,1
	Kargo Bagian Dalam	m ³	4,5
Performa Pendingin	Mesin pendingin		Denso DS21
	Temperatur terendah	°C	-25
	Temperatur tertinggi	°C	20
Garansi Boks & Sistem Pendingin			1 Tahun / 20.000 km

DRY BOX

(All Standard Type)



Material		Alumunium Extrusion	
Dimensi Kendaraan (P x L x T)		mm	5.050 x 1.800 x 2.400
Dimensi Kargo	Kargo Bagian Luar (P x L x T)	mm	2.400 x 1.800 x 1.500 *dengan pintu samping lebar bertambah 80
	Kargo Bagian Dalam (P x L x T)	mm	2.300 x 1.680 x 1.360
Volume	Kargo Bagian Luar	m ³	6,5
	Kargo Bagian Dalam	m ³	5,3
Garansi Boks			1 Tahun / 20.000 km

Tersedia pilihan menggunakan atau tanpa menggunakan pintu samping.

TERUS MAJU DENGAN KONVERSI BERAGAM KEBUTUHAN

SOLUSI KAROSERI

Tersedia pilihan landasan penumpang dan landasan barang yang dapat memenuhi semua kebutuhan karoseri Anda.

BISNIS



MOBILE CAFE



FOOD TRUCK

HOBI



CAMPERVAN



TOWING MOTOR

PELAYANAN PUBLIK



TOYOTA MOBILE SERVICE (TMS)



KAS KELILING



AMBULANCE



ANIMAL RESCUE



MOBILE WASTE STATION

Opsi modifikasi hanya ilustrasi, silahkan hubungi Dealer Toyota terdekat untuk informasi lebih lanjut.
Desain Mobile Cafe bekerja sama dengan Toko Kopi Tuku.

SPESIFIKASI

TIPE MODEL	Bensin				Diesel		
	2.0 Standard M/T	2.0 High M/T	2.4 Standard M/T	2.4 High M/T	2.4 High A/T		
PERFORMA MESIN	Daya Maksimum ps/rpm	139/5.600		149/3.400			
	Torsi Maksimum Nm (kgm)/rpm	183 (18,7)/4.000		343 (34,9)/1.400-2.800		400 (40,7)/1.600-2.000	
	Kapasitas Mesin cc	1.998		2.393			
	Kapasitas Tangki liter	55,3		55			
PERBANDINGAN GIGI	1 st	4.313		3.600			
	2 nd	2.330		2.090			
	3 rd	1.436		1.488			
	4 th	1.000		1.000			
	5 th	0.838		0.687			
	6 th	-		0.580			
	Final	4.555		3.583			
Reversed	4.220		3.732				
DIMENSI KENDARAAN	Panjang mm			4.970			
	Lebar mm			1.785			
	Tinggi mm			1.740			
	Jarak Sumbu Roda mm			2.750			
DIMENSI BAK	Bukaan Dek mm	C&C / 3 Way / 1 Way	1 Way	C&C / 3 Way / 1 Way	1 Way	C&C / 1 Way	
	Panjang Dek mm			2.385			
	Lebar Dek mm			1.774			
	Tinggi Dek mm			340			
TRANSMISI	Transmisi	5-Speed M/T			6-Speed A/T		
SUSPENSI	Depan	Coil Spring					
	Belakang	Leaf Spring Rigid Axle					
SETIR	Pengaturan Setir	Tilt with Lock					
EKSTERIOR	Ban	195 R14 C	215/65 R16 C	195 R14 C	215/65 R16 C		
	Electric Outer Mirror	Tidak ada				Ada	
INTERIOR	Power Outlet				12 V		
	Sandaran Kepala	Tidak ada	Ada	Tidak ada	Ada		
	Tipe Kursi	Bench				Separate	
	AC	Ada		Blower	Ada		
Power Window	Tidak ada				Ada		
KENYAMANAN	Audio	1DIN Audio with USB, AUX, BT			2DIN Audio with USB, AUX, BT		
KEAMANAN	ABS + EBD	Tidak ada	Ada	Tidak ada	Ada		
	Air Bag	Tidak ada	Ada (D+P)	Tidak ada	Ada (D+P)		
	Immobilizer	Tidak ada	Ada	Tidak ada	Ada		
	Rem Depan	Disc 14"					
	Rem Belakang	Drum					
	Sabuk Pengaman	Less Pretensioner & Force Limiter (D+P)	Pretensioner & Force Limiter (D+P)	Less Pretensioner & Force Limiter (D+P)	Pretensioner & Force Limiter (D+P)		
LAINNYA	Alternator	80 A					
	Berat Kotor Kendaraan kg	2.570		2.670		2.680	
	Radius Putar Minimal m	4,9	5,3	4,9	5,3		

AVAILABLE COLOR

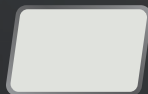

Putih
(All Type)

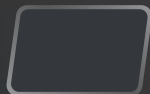

Abu-Abu Metalik
(High Type)

- Untuk peningkatan mutu dan penyesuaian dengan perkembangan teknologi, PT Toyota-Astra Motor sewaktu-waktu dapat mengubah spesifikasi, perlengkapan standar atau data lain dalam lembar spesifikasi ini. / PT Toyota-Astra Motor reserves the right to alter any details of specifications and equipments without prior notice.
- Spesifikasi dan kelengkapan dapat berbeda dengan gambar di brosur ini, tergantung model kendaraan. / Details and specifications may differ from the picture shown, depending on models.



SCAN HERE
FOR MORE INFORMATION



ALL NEW HILUX
RANGGA
SCAN HERE FOR
MORE INFORMATION

Authorized Toyota Dealer

CEKAMAN / 1 / 09 / 2024

www.toyota.astra.co.id

PT TOYOTA-ASTRA MOTOR
Jl. Laksda Yos Sudarso Sunter II
Jakarta 14330



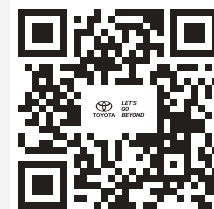

SCAN UNTUK INFO LEBIH LANJUT

ALL NEW **HILUX**
RANGGA
TERUS MAJU USAHA MELAJU